



NEXATM
NPWT System

**INSTRUCTIONS FOR USE
(INTERNATIONAL VERSION)**

NEXATM
MEDICAL
An AOTI Company



All descriptions and specifications are correct at time of print. Information may be subject to change at any time.

TABLE OF CONTENTS

Introduction	4
Intended use	4
Indications and contraindications.....	5
Precautions.	5
Warnings.....	7
Setting up the device.....	9
NEXA™ system and components.	10
Inserting the NEXA™ fluid container pack.	11
Removing the NEXA™ fluid container pack.	12
Operating the NEXA™ device.	13
Days Remaining / Device Lifetime Alert.	14
Using the Carry Case.....	15
Applying the NEXA™ dressing.	16
Removing the NEXA™ dressing.	17
Troubleshooting.....	18
Cleaning and maintenance.....	19
Disposal.....	19
Technical specifications.	20
Explanation of symbols.	21
Electromagnetic Compatibility	22
Consumables and spares.....	26
Contact information.....	26





WARNING: DO NOT ATTEMPT TO USE THIS DEVICE BEFORE READING THE INSTRUCTIONS FOR USE!

INTRODUCTION:

Description of the NEXA™ NPWT System.

The NEXA NPWT System is an integrated negative pressure wound management system for use in home, acute and extended care settings. The system applies a negative pressure to a sealed wound dressing and promotes wound healing through the removal of exudates into a disposable fluid container.

The system consists of the following key components:

1. NEXA Device: A portable device that contains a pump and a rechargeable Battery and is supplied with a Power Supply, and a Carry Case.
2. NEXA Fluid Container Pack: A single use polymeric flexible fluid container that stores the exudate removed from the wound.
3. NEXA Dressing (-75mmHg or -125mmHg) : Sterile single use wound dressing components that are in contact with the wound tissue and a means of sealing to the peri-wound area. Interconnect tubing includes an integrated negative pressure relief valve that limits the maximum pressure able to be applied to the wound and are pre-set and not adjustable by the user.

INTENDED USE:

The NEXA NPWT system is intended for patients who may benefit from the application of negative pressure to the wound to promote wound healing through the removal of excess exudates, infectious material and tissue debris.

It is intended for use in home care, long-term care and acute settings only when prescribed by a Health Care Professional.

NEXA NPWT may be used in a clinical environment such as a hospital or clinic when treatment is under the supervision of a Health Care Professional.

NEXA NPWT foam dressings should not be placed directly in contact with exposed blood vessels, anastomotic sites, organs or nerves

NEXA NPWT may be used on any part of the body with a wound that is not contraindicated.

INDICATIONS FOR USE:

Appropriate wound types to include:

- Chronic wounds
- Pressure ulcers
- Diabetic foot ulcers
- Venous leg ulcers
- Acute wounds
- Surgical incisional wounds
- Subacute and dehisced wounds
- Partial thickness burns, flaps and grafts

CONTRAINDICATIONS FOR USE:

The device is not recommended for treatment of the following conditions:

- Presence of necrotic tissue
- Malignancy in wound
- Untreated Osteomyelitis
- Untreated malnutrition
- Exposed arteries, veins, nerves, or organs
- Use over anastomotic sites
- Non-enteric and unexplored fistulas
- Necrotic tissue with eschar

PRECAUTIONS:

Precautions should be taken for patients with the following conditions:

- Patients on anticoagulation medicine or who have active bleeding or who have difficult wound haemostasis should be treated with caution. These patients are at an increased risk for bleeding and bleeding complications and should be treated and monitored by properly trained medical caregivers in a controlled setting.
- Wounds that are in close proximity to blood vessels, organs, muscle, and fascia: All blood vessels, organs, muscles, and fascia that are in close proximity to the wound site and/or are exposed and /or are near the skin surface should be properly protected prior to initiating therapy. Patient with infections in the wound and or other parts of the body have to receive proper systemic treatment.
- Irradiated vessels and tissue. These patients are at an increased risk for bleeding and bleeding complications and should be treated and monitored by properly trained medical caregivers in a controlled setting.
- Bony fragments. Sharp edges from bony fragment may puncture blood vessels, organs, muscles, and fascia and may lead to bleeding. Proper care should be taken to cover the bony fragments and protect the wound area and other areas from bleeding.
- Check wound dressing periodically to ensure there is no build up of wound fluid or evidence of any bleeding.
- Dressings should be routinely changed every 48 - 72 hours but no less than 3 times a week or when the wound shows signs of infection.
- Do NOT continue using the system if a Haematoma is observed when changing the dressing.



PRECAUTIONS:

- Spinal Cord Injury: In the event a patient experiences autonomic dysreflexia, discontinue the use of the NEXA™ system and seek advice.
- Bradycardia: The NEXA™ NPWT system must not be placed in proximity to the vagus nerve.
- Enteric Fistulas: The NEXA™ NPWT system is not recommended if enteric fistula effluent management is the sole purpose of management.
- Consider using a skin preparation product to protect the periwound skin. If any signs of irritation appear, cease use of the NEXA™ NPWT System.
- Circumferential Dressing Application: Do not use circumferential dressings unless required to maintain a seal in the presence of anasarca or excessively weeping extremities. It is recommended to use smaller strips to obtain a seal rather than one large drape. Do not stretch the drape upon securement.
- Care must be taken to assess the wound for anastomotic sites. If present, use a non-adherent interface layer between the wound and the foam.
- To prevent tissue ingrowth, consider using an interface layer between the foam and wound. Also consider selecting a lower pressure dressing.

GENERAL PRECAUTIONS FOR ALL INDICATIONS FOR USE:

- It is important that a doctor, nurse or other qualified healthcare provider evaluates the patient to ensure that the use of this device is an appropriate therapy.
- Prior to issuing the system, the patient should be assessed for their knowledge, skill level and amount of training required enabling the patient to use the system themselves.
- To reduce the risk of transmission of blood-borne pathogens, regardless of the diagnosis or presumed infection status, all users should take suitable precautions as defined in locally applicable standard operating procedures for infection control.

WARNINGS:

The following Warning statements describe the potential for serious consequences to the patient, such as death, injury, or adverse reactions. Failure to read and follow all instructions in this manual prior to use may result in death or injury of the patient.

- Do not use any Power Supply to re-charge the device other than that supplied.
- The socket in which the Power Supply is connected must be accessible at all times.
- Only use dressings and accessories that are approved for use with the NEXA™ Device.
- Physician should consider the patient's size and weight when prescribing this device.
- The device is not safe for use with an MRI and must be disconnected from the patient prior to MRI.
- Do not use the device in a Hyperbaric Chamber or in the presence of flammable gases. The patient's dressing may remain in place when disconnected from the unit.
- To prevent unintentional gauze/foam retention, all dressings should be carefully removed from the wound and the entire wound bed. Upon removal of the dressings, the wound bed should be cleaned in accordance with standard wound care practices (or facility guidelines), prior to the application of new sterile dressing.
- Ensure that there are no pockets left in the wound or wounds after application of the dressings.
- Infected wounds must be inspected more frequently for signs of increased infection or sepsis.
- Patients who do not have adequate haemostasis, and who are currently taking anticoagulation or platelet aggregation inhibitor therapy, have an increased risk of bleeding with or without the NPWT device.
- Defibrillation: Remove the NEXA™ Dressing if defibrillation is required in the area of dressing placement. The dressing may inhibit transmission of electrical energy and/or patient resuscitation.
- All arteries, veins, tendons, ligaments, nerves, and organs must be covered completely prior to application of the device.
- Only use with caution on any patient with increased risk of bleeding due to the presence of weakened or friable blood vessels or organs, conditions when suture of the blood vessels has taken place or when there is (localised to the wound) any infection, trauma, or radiation, as if not controlled well, could potentially be fatal.
- Infected tissue such as blood vessels may have a weakened structure and have to be treated with care. Infected blood vessels may bleed more readily than normal blood vessels.
- There is a risk of strangulation or asphyxiation from tubing, cables and the Carry Case strap. Retain excess tubing to patients body using supplied drape.



WARNINGS:

- In the event of a device malfunction return the equipment to the authorised service centre.
- There are no serviceable parts inside the therapy unit therefore do not open the device.
- No modification of the device is allowed!
- The device must never be used to remove explosive gases and flammable or corrosive fluids.
- The device must not be operated in damp rooms or when taking a bath or shower. Avoid moisture on plug and switches.
- Never plunge the device into water or liquids, not even when it is switched off.
- The unit must not be operated in splash water range, near sources of steam such as kettles or in locations where there is a danger of explosion.
- EMC Statement: Although the device is compliant with the current EMC regulations applicable, the device may be susceptible to EMC radiation and action should be taken to avoid exposure.
- The NEXA™ NPWT System is a medical device, not a toy. Keep away from children, pets and pests as they can damage the NEXA™ Device, NEXA™ Dressing and Fluid Container Pack and potentially affect their performance. Keep the system free from lint and dust as they may cause damage and affect performance.
- Keep the system away from sources of heat such as heaters, fireplaces or direct sunlight.
- **TO ENSURE THE SYSTEM IS WORKING CORRECTLY, THE DRESSING AND DEVICE SHOULD BE CHECKED REGULARLY THROUGHOUT THE DAY TO CHECK FOR FLUID MOBILITY IN THE TUBING AND THAT THE GREEN LED IS LIT.**
- **THE NEXA™ DEVICE DOES NOT HAVE AUDIBLE OR VISUAL ALARMS TO ALERT USERS TO A LEAK OR BLOCKAGE IN THE SYSTEM. PLEASE REFER TO THE TROUBLESHOOTING SECTION TO DETERMINE HOW A LEAK OR BLOCKAGE MAY BE DETECTED AND RESOLVED.**
- **THE FOAM AND DRAPE DRESSING COMPONENTS, THAT COME INTO PATIENT CONTACT, MAY CAUSE AN ALLERGIC REACTION. ENSURE THE FOAM DOES NOT OVERLAP ON TO HEALTHY SKIN AND ALWAYS MONITOR THE SKIN FOR ANY SIGNS OF REACTION.**
- **ANY SERIOUS INCIDENT THAT HAS OCCURRED IN RELATION TO THE DEVICE SHOULD BE REPORTED TO THE MANUFACTURER AND THE COMPETENT AUTHORITY OF THE MEMBER STATE IN WHICH THE USER AND/OR PATIENT IS ESTABLISHED.**

SETTING UP THE DEVICE:

- **DO NOT ATTEMPT TO USE THE DEVICE UNTIL READING THE INSTRUCTIONS.**
 - The device should only be administered by persons who have been trained in its operation according to the instruction guidelines issued by the supplier or qualified medical staff.
 - Before using the device, please read the indications, warnings, precautions and contraindications.
 - Check function of the unit prior to use.
 - **FULLY CHARGE THE NEXA™ DEVICE PRIOR TO FIRST USE. CHARGING TAKES APPROXIMATELY 4 HOURS.**
 - **THE DEVICE HAS A SLEEP MODE. IF THE CHARGING LIGHT IS NOT FLASHING, TURN THE DEVICE ON AND OFF AGAIN TO WAKE IT.**
 - **FOR OPTIMUM PERFORMANCE AND SAFETY, CHARGE THE DEVICE IN AN AMBIENT TEMPERATURE OF 20°C +/-5°C (68°F +/-9°F)**
 - Prior to connecting to the power supply adapter, check whether the voltage corresponds with the in building voltage.
 - Never connect the Power Supply to defective power sockets. Keep power supply adapter and cable away from external heat sources.
 - The device should not be charged or started up if:
 - The power cord or plug are defective
 - The device is not functioning properly
 - The device has been damaged / dropped
 - The device has been dropped into water
 - Obvious defects might restrict safe operation
- In any case, remove the Power Supply from the electrical socket and have the unit checked by qualified personnel authorised by Nexa Medical.
- The device must be used within the Carry Case at all times except to replace the Fluid Container Pack.
 - It is the responsibility of the clinician or trained caregiver to determine if the patient's condition allows for mobile use.
 - The device can be charged whilst in its Carry Case by pulling back the tab near the socket and inserting the plug.
 - Operation of the device is possible while the battery is charging.
 - Pay attention to the ambient conditions described in the technical data.
 - If the device is operated at ambient temperatures outside the stated temperature range (see "Technical Data"), the performance may be reduced and the unit or the electronics and battery may get damaged.
 - If the device has been stored for a pro-longed period without use then the battery should be checked by re-charging fully in accordance with the Instructions, and if necessary returned to a qualified organisation to replace the battery.



NEXA™ NPWT SYSTEM AND COMPONENTS:

NEXA™ Device

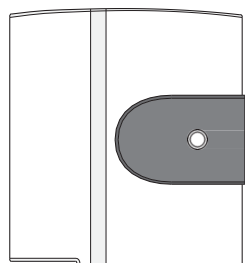

Power Supply input for charging

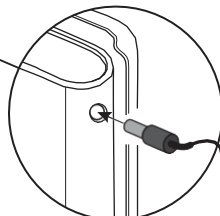

NEXA™ Power Supply

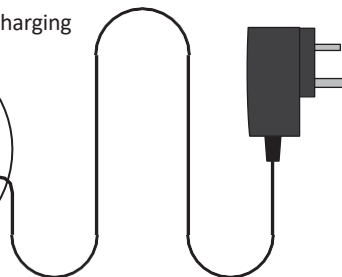

NEXA™ Carry Case



NOTE: THE DEVICE HAS A SLEEP MODE. IF THE CHARGING LIGHT DOES NOT FLASH WHEN CONNECTED TO THE MAINS POWER, TURN THE DEVICE ON AND OFF AGAIN TO WAKE THE DEVICE FROM ITS SLEEP MODE.

Consumables (sold separately)

NEXA™ Fluid Container Pack

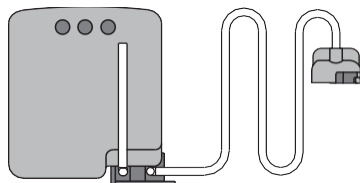

NEXA™ Dressing (-75mmHg or -125mmHg)

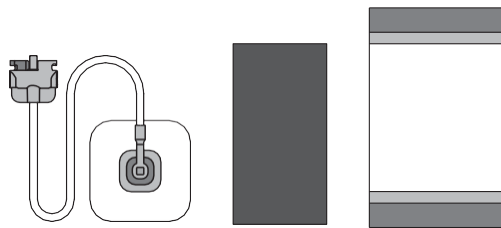

INSERTING THE NEXA™ FLUID CONTAINER PACK:

- NOTE:**
- IT IS RECOMMENDED TO REPLACE THE FLUID CONTAINER TWICE A WEEK TO ENSURE OPTIMUM THERAPY LEVELS AND REDUCED ODOUR.
 - IN ANY CASE IT MUST BE CHANGED ONCE A WEEK, IRRESPECTIVE OF FLUID LEVELS.

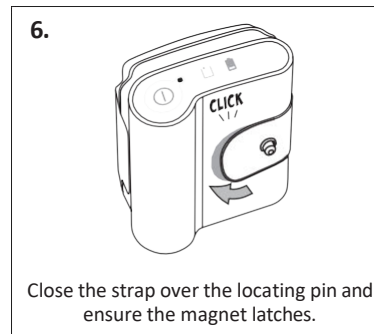
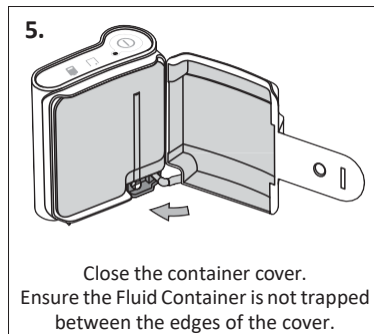
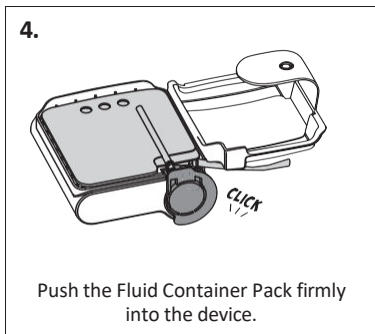
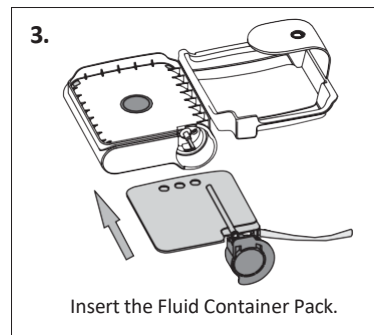
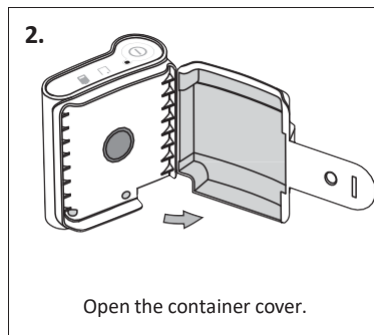
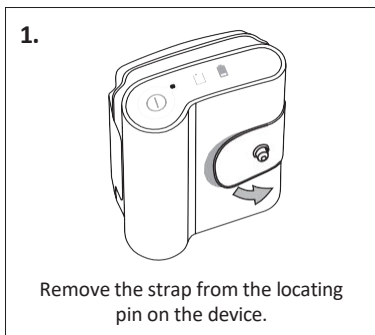



REMOVING THE NEXA™ FLUID CONTAINER PACK:

NOTE: DISPOSE OF THE USED FLUID CONTAINER PACK ACCORDING TO INSTITUTION AND LOCAL ENVIRONMENTAL REGULATIONS.

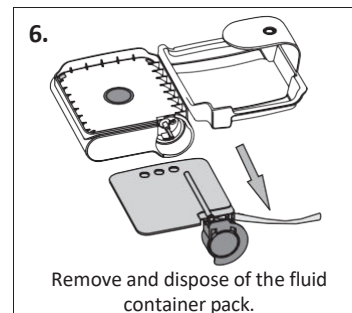
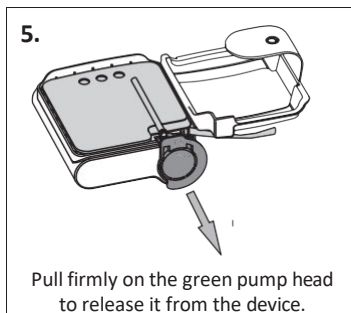
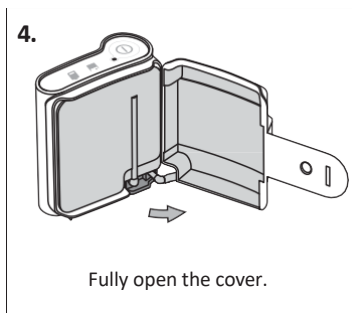
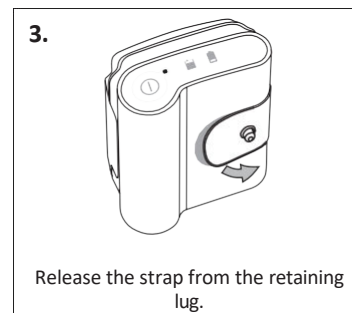
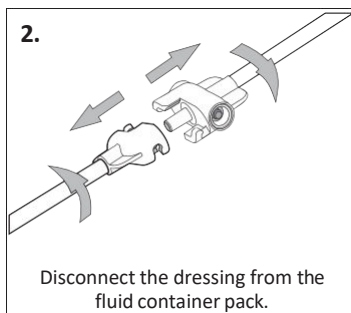
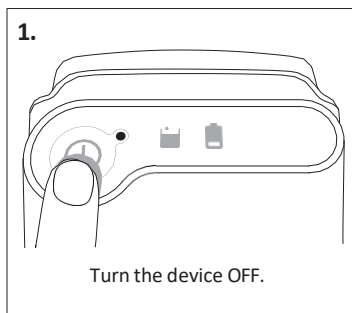

OPERATING THE NEXA™ DEVICE:

NOTE: DO NOT TURN THE DEVICE ON WITHOUT A FLUID CONTAINER PACK INSERTED AND A NEXA™ DRESSING CONNECTED.

TURNING THE DEVICE ON

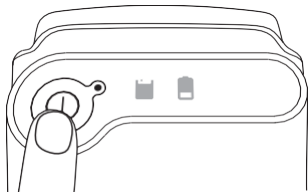

Press the Power button to turn the device ON. The green LED will illuminate.

If the green LED does not illuminate, charge the device immediately using the Power Supply provided and turn the device ON to wake it from sleep mode. The orange light will flash to indicate charging. Charging takes approximately 4 hours. The device will run for approximately 10 hours with a fully charged battery.

The device will start at maximum speed to help apply a negative pressure to the dressing quickly. Observe the dressing and foam to ensure there is a good seal and the foam compresses.

After 3 minutes, the device AUTOMATICALLY reduces its speed. This will be the normal operating speed.

To turn the device OFF, press the power button once and the green LED will turn off.

THE USER INTERFACE



Green LED is lit = Power is ON

Therapy is ACTIVE



Green LED is lit = Power is ON

Orange LED is lit = Battery LOW

Therapy is ACTIVE

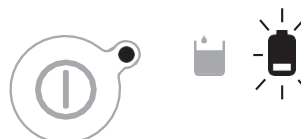

Green LED is lit = Power is ON

Orange LED flashes = Battery CHARGING

Therapy is ACTIVE



Green LED is lit = Power is ON

Red LED is lit = Container is FULL or Strap is not engaged

Therapy is INACTIVE



DAYS REMAINING FEATURE:

The device has a feature to see how many days remain on the device.
 Open the grey cover.
 Press and hold the grey button, then press and hold the power button for 8 seconds.
 The RED light will flash to indicate the 10's and the ORANGE light will flash to indicate the 1's.

For example:
 4 Red flashes and 2 Orange flashes will indicate 42 days remaining.
 2 Red flashes and 8 Orange flashes will indicate 28 days remaining.

To resume therapy, press the power button.

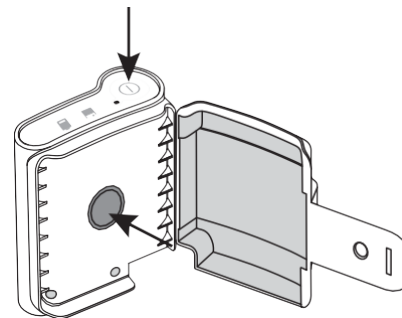

DEVICE LIFETIME ALERT:

The device has a lifetime of 1344 hours (8 weeks) continuous use. The device will alert the user when 3 days are remaining.

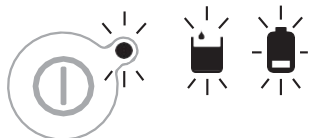

At the beginning of the 3 day warning period, all LED's will flash for a short period of time.

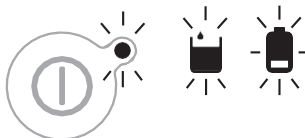

Every hour all LED's will flash for a short period of time.

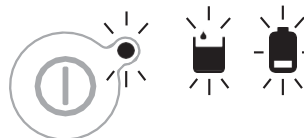

At 1344 hours, all LED's will flash for a short period of time and the device will shut down.



If the device is switched on following shut down, all LED's will stay illuminated but the device will not function.

If the device is switched off and on again during the 3 day warning period, all LED's will flash for a short period of time.

USING THE CARRY CASE:



The carry case can be attached to the patient using the shoulder strap.

To charge the device, push the Power Supply connector through the opening in the carry case into the socket of the device. Place on a table to remove the device from the carry case.

1.

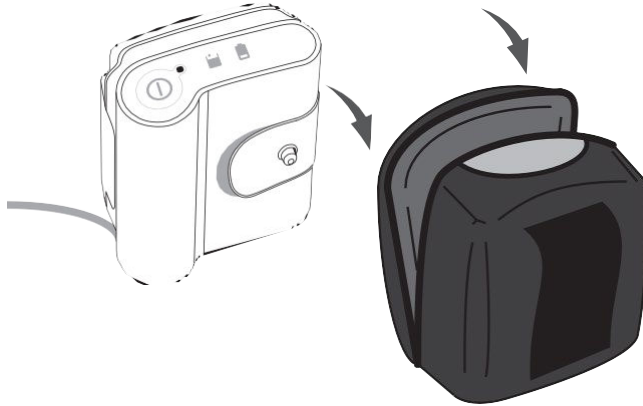

2.

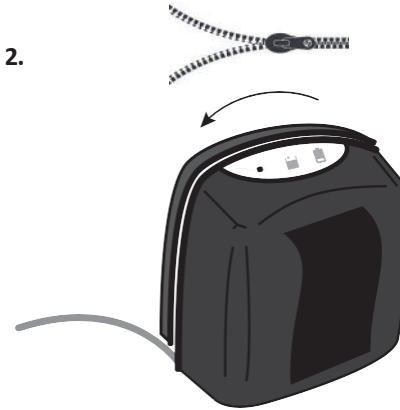

POSITIONING THE NEXA™ NPWT SYSTEM:

Keep the device in the upright position when it is operating.

This will enable optimum performance and allow for the maximum 120ml of fluid to be contained in the Fluid Container.

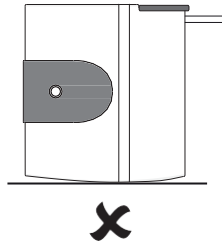
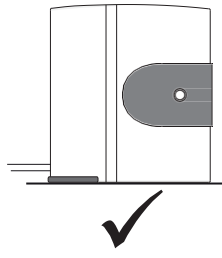

APPLYING THE NEXA™ DRESSING (TO BE PERFORMED BY A CLINICIAN ONLY):

- NOTE:**
- ALWAYS ENSURE THE DEVICE IS SWITCHED OFF WHEN CONNECTING THE DRESSING.
 - SELECT THE APPROPRIATE DRESSING PRESSURE VALUE, -75mmHg OR -125mmHg, AS CLEARLY LABELLED ON THE PACKAGING.
 - DO NOT USE THE STERILE DRESSING IF THE PACKAGING HAS BEEN DAMAGED OR IS ALREADY OPEN.
 - DRESSINGS SHOULD BE CHANGED **EVERY 48 - 72 HOURS BUT NO LESS THAN 3 TIMES A WEEK**. NOT TO BE RE-STERILISED OR RE-USED.

1.



Clean the wound and prepare the surrounding skin.

2.

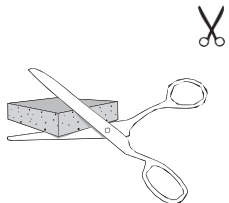

Cut the foam to suit the wound size. Do not cut over the wound.

3.

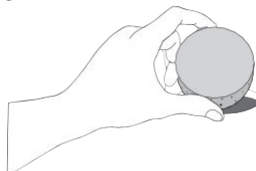

Place the foam into the wound, ensuring it does not overlap on to healthy skin as there is a risk of allergic reaction.

4.

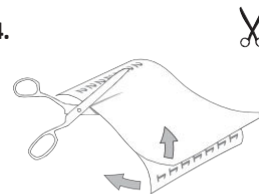

Trim the drape to overlap the wound and foam by approximately 2 cm. Remove layer 1.

5.

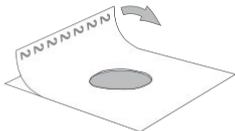

Apply the drape to the skin and press down edges firmly. Remove layer 2.

6.

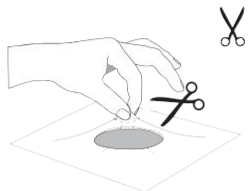

Pinch the drape over the foam and cut a 1cm hole.

7.

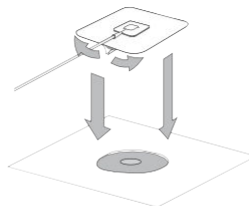

Peel off the pad film backing layer and apply to the drape, aligning hole with the pad.

8.

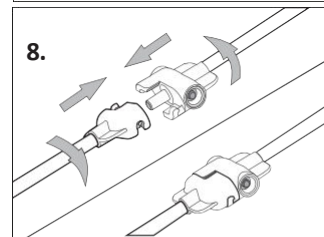

Connect dressing to the Fluid Container Pack. Push connector together and twist to lock.



REMOVING THE NEXA™ DRESSING (TO BE PERFORMED BY A CLINICIAN ONLY):

NOTE: SOME PATIENTS MAY EXPERIENCE PAIN UPON DRESSING REMOVAL. REMOVE DRAPES GENTLY.

1. TURN THE NEXA™ DEVICE OFF.
2. DISCONNECT THE DRESSING FROM THE FLUID CONTAINER PACK.
3. GENTLY STRETCH THE DRAPE HORIZONTALLY TO RELEASE THE ADHESIVE DRAPE FROM THE SKIN.
4. DO NOT PULL THE DRAPE VERTICALLY AS THIS WILL CAUSE MORE PAIN.
5. GENTLY REMOVE THE ENTIRE DRAPE FROM THE PATIENT.
6. GENTLY REMOVE THE FOAM FROM THE WOUND ENSURING THAT NO SMALL FOAM PIECES ARE LEFT IN THE WOUND.
7. CLEAN THE PERIWOUND OF RESIDUE WITH ALCOHOL SWABS.
8. DISPOSE OF THE USED DRESSING ACCORDING TO INSTITUTION AND LOCAL ENVIRONMENTAL REGULATIONS.

BEFORE APPLYING A NEW DRESSING ENSURE THE SKIN IS DRY AND CLEAN AND NO FOAM REMAINS IN THE WOUND. FOLLOW THE 'APPLYING THE NEXA™ DRESSING' INSTRUCTIONS.



TROUBLESHOOTING:

LEAKS: There is no leak alarm as the device will continue to remove fluid, even with reduced vacuum, thereby reducing the potential for skin maceration. If the device is unable to pull down the dressing or the dressing is not compressed, check the following:

- Dressing is firmly sealed around the wound. Use additional film drape if necessary around the drape edges.
- Check dressing connector is properly locked.
- Fluid Container Pack is fully engaged into the device.

BLOCKAGES:

If there is no fluid mobility in the tubing and the dressing is not compressed, there may be a blockage.

A blockage will also cause the device to make an uncharacteristic slapping noise.

- To resolve a blockage, check that there is no kinking in the tubing or the tube is occluded. If there is, either straighten the kink or replace the dressing and/or Fluid Container Pack.

BATTERY LOW INDICATOR - When the battery reaches low charge, the orange Battery Low light will be lit to indicate approximately 2 hours of battery life remaining. Connect the power supply to the device and plug into a power outlet. Once charging, the light will flash intermittently to indicate charging is occurring. Charge time is approximately 4 hours. The device can be used whilst charging.

When the device is fully charged, the orange light will go out. The device will operate on battery only for approximately 10 hours.

FLUID CONTAINER FULL/STRAP ENGAGED INDICATOR

When the red light is lit, the device will stop running.

If the red light is lit there are two possible reasons:

1. The Fluid Container is full and requires changing.
 2. The strap has not been correctly attached to the device. Ensure the Strap is engaged over the fastener on the front of the device.
- If the Fluid Container is full of air, ensure the device is operated in its upright position.
 - When a new Fluid Container Pack has been installed and the strap engaged, the red light will go out and the device will restart.
 - The device will restart at maximum speed for 3 minutes. If required, open and close strap to give an additional 3 minutes of high speed.

LIFETIME ALERT - If the device shows all the LED's flashing or all LED's permanently on, refer to page 14 for the Device Lifetime Alert.



CLEANING AND MAINTENANCE:

Always unplug the power unit from electrical outlet before cleaning. Ensure any local or institutional regulations on hygiene are complied with. The NEXA™ Device is non-serviceable.

The NEXA™ Device is suitable for use by multiple patients. It is necessary to clean and disinfect the device between patients. Wear suitable gloves for cleaning / disinfection. Routine cleaning of device can be done by wiping down with damp cloth using disinfectant and water or non-aggressive cleaning material.

WARNING! TAKE SPECIAL PRECAUTION TO ENSURE THAT NO CLEANSING SOLUTION IS ABLE TO PENETRATE INTO THE EQUIPMENT. DO NOT RE-USE THE FLUID CONTAINER PACK. DISPOSE OF PROPERLY ACCORDING TO LOCAL AND INSTITUTIONAL GUIDELINES.

DISPOSAL:

The device is made from various electronics, plastics and a Lithium-Ion battery. When the pump is ready for disposal, facilities should follow the local governing guidelines regarding sanitation of disposed device components.

The used Fluid Container Packs, tubes and dressings should be disposed according to the local or facility guidelines for handling infected or bio-hazardous materials.

None of the items should be disposed together with household or facility refuse. Incorrect disposal can have harmful effects on the environment and public health.

CAUTION! PAY ATTENTION TO COUNTRY-SPECIFIC, LOCAL, AND FACILITY REGULATIONS WITH RESPECT TO DISPOSAL, ESPECIALLY WITH REGARD TO DISPOSAL OF USED BATTERIES.



TECHNICAL SPECIFICATIONS:

Flow rate of pump..... maximum 50 ml /min at high speed
 maximum 40ml/min at low speed

Negative pressure dependent on dressing selection

-125mmHg Dressing..... Max. -125 mmHg (-16.7 kPa) +/-20%
 -75mmHg Dressing..... Max. -75 mmHg (-10 kPa) +/-20%

Internal Rechargeable battery

Type..... Lithium-ion
 Capacity 2550mAh
 Battery Life..... 8 weeks
 Battery Charge Time..... ~ 4 hours
 Battery Run Life..... ~ 10 hours
 External Power Supply Input. AC 100-240V / 50-60Hz
 Power Consumption..... Max: 15W

Dimensions (WxHxD)..... W 10.5cm (4.1 in) x H 11.5cm (4.5 in)
 x D 6.5cm (2.5 in)

Weight of system. 0.42kg (0.9 lb) excluding Carry Case

Fluid Container Capacity..... ~120ml

Risk class. Ila (Nexa NPWT Device)
 I Ib (Nexa NPWT Dressing)
 I (Nexa Fluid Container Pack)

in accordance with MDD 93/42/EEC amended by 2007/47/EC Annex IX,
 Medical Device Regulations 2002 (SI 618) (UKCA) and EU MDR 2017/745
 Annex VIII.

Operating Conditions

Temperature Range..... 5°C (41°F) to 40°C (104°F)
 For optimum performance and safety, charge the device in an ambient
 temperature of 20°C +/-5°C (68°F +/-9°F)
 Relative Humidity Range..... 15-93% non-condensing
 Atmospheric Pressure Range. 700 hpa to 1060 hpa
 Expected Life of NEXA™ Device..... maximum 1344 hours (56 days
 of actual runtime)
 No serviceable parts
 Duration of use of NEXA™ Dressing..... Dressings should be changed
 48 to 72 hours but no less than
 3 times a week.

Transport and storage conditions

Temperature Range:
 (NEXA™ Device and Fluid Container Pack). -25°C (-13°F) to +70°C (158°F)
 (NEXA™ Dressing)..... 10°C (50°F) to +40°C (104°F)
 Relative Humidity Range 0-93% non-condensing.
 Degree of protection against
 electric shock (IEC60601-1)..... Type BF Applied part; Class II
 Mode of operation..... Continuous
 Protection Against Hazards of Explosion. Not Protected (Ordinary)
 Protection Against Ingress of Liquids..... NEXA™ Device: IP20
 NEXA™ Carry Case: IP02
 Method of sterilisation..... NEXA™ Dressing: Supplied sterile by
 Ethylene Oxide (ETO)
 The NEXA™ Device and Fluid Container Pack are not intended to be sterilised.

EXPLANATION OF SYMBOLS:



Method of Sterilisation - Ethylene Oxide



Keep out of direct sunlight



Refer to Instructions for Use



Consult Instructions for Use



Do not use if package is open or damaged



Keep Dry



Do Not Re-sterilize



Manufacturer



Fragile



Conforms with the EU Medical Device Regulation (2017/745) and MDD 93/42/EEC

Rx Only

Prescription only



Date of manufacture



Expiry Date



Caution



Do not re-use



WEEE Directive 2012/19/EU

IP02

Ingress Protection Rating:

No protection ingress of solid objects; Protected against falling drops of water, if the case is disposed up to 15° from vertical.

IP20

Ingress Protection Rating:

Protected against solid objects over 12.5mm; No protection against ingress of liquids.



MR Unsafe



Humidity Limitations



Temperature Limitations



LOT Number



Reference Number



Conforms to Medical Devices Regulations 2002 (SI 2002 No 618, as amended) (UK MDR)



ELECTROMAGNETIC COMPATIBILITY:

Guidance and manufacturer's declaration - electromagnetic emissions		
The NEXA™ Device is intended for use in the electromagnetic environment specified below. The customer or the end user of the NEXA™ Device should assure that it is used in such environment.		
Emissions Test	Compliance	Electromagnetic environment - guidelines
RF emissions - CISPR 11 (Radiated and Conducted)	Group 1	The NEXA™ Device uses RF energy only for its internal function. Therefore, its RF emissions are very low and are not likely to cause any interference in nearby electronic equipment. The NEXA™ Device is suitable in all establishments, including domestic establishments and those directly connected to the public low-voltage power supply network that supplies buildings used for domestic purposes.
RF emissions - CISPR 11 (Radiated and Conducted)	Class B	
Harmonic emissions EN 61000-3-2	Class A	
Voltage Fluctuations / Flicker emissions EN 61000-3-3	Complies	

ELECTROMAGNETIC COMPATIBILITY:

Guidance and manufacturer's declaration - electromagnetic immunity			
The NEXA™ Device is intended for use in the electromagnetic environment specified below. The customer or the end user of the NEXA™ Device should assure that it is used in such environment.			
Immunity Test	EN/IEC Test Level	Compliance Level	Electromagnetic environment - guidelines
Electrostatic discharge (ESD) IEC 61000-4-2	±8 kV contact ±15kV air	±8 kV contact ±15 kV air	Floors should be wood, concrete or ceramic tile. If floors are covered with synthetic material, the relative humidity should be at least 30%.
Electrical fast transient / burst IEC 61000-4-4	±2 kV for power supply lines ±1 kV for input/output lines	±2 kV for power supply lines ±1 kV for input/output lines	Mains power quality should be that of a typical commercial or hospital environment.
Surge IEC 61000-4-5	±1 kV differential mode (line to line) ±2 kV common mode (line to earth)	±1 kV differential mode (line to line) ±2 kV common mode (line to earth)	Mains power quality should be that of a typical commercial or hospital environment.
Voltage dips, short interruptions and voltage variations on power supply input lines EN 61000-4-11	<5% Ut (>95% dip in Ut) for 0.5 cycle 40% Ut (60% dip in Ut) for 5 cycles 70% Ut (30% dip in Ut) for 25 cycles <5% Ut (>95% dip in Ut) for 5 secs	<5% Ut (>95% dip in Ut) for 0.5 cycle 60% dip in Ut for 5 cycles 30% dip in Ut for 25 cycles >95% dip in Ut for 5 secs	Product has internal battery backup. Mains power quality should be that of a typical commercial or hospital environment. If the user of the NEXA™ Device requires continued operation during power mains interruptions, it is recommended the device be powered from an uninterruptible power supply or a battery.
Power Frequency (50/60 Hz) magnetic field IEC 61000-4-8	3 A/m	3 A/m	Power frequency magnetic fields should be at levels characteristic of a typical location in a typical commercial or hospital environment.
Note: Ut is the mains voltage prior to application of the test level			



ELECTROMAGNETIC COMPATIBILITY:

Guidance and manufacturer's declaration - electromagnetic immunity			
The NEXA™ Device is intended for use in the electromagnetic environment specified below. The customer or the end user of the NEXA™ Device should assure that it is used in such environment.			
Immunity Test	EN/IEC Test Level	Compliance Level	Electromagnetic environment - guidelines
Conducted RF IEC 61000-4-6 Radiated RF IEC 61000-4-3	3Vrms 150kHz to 80 MHz 3V/m 80 MHz to 2.5 GHz	3Vrms 150kHz to 80 MHz 3V/m 80 MHz to 2.5 GHz	Portable and mobile RF communications equipment should be used no closer to any part of the NEXA™ Device, including cables, than the recommended separation distance calculated from the equation applicable to the frequency of the transmitter. Recommended separation distance $d=1.2VP$ $d=1.2VP$ (80 MHz to 800 MHz) $d=2.3VP$ (800 MHz to 2.5 GHz) where P is the maximum output power rating of the transmitter in watts (W) according to the transmitter manufacturer and d is the recommended separation distance in meters (m). Fields strengths from fixed RF transmitters, as determined by an electromagnetic site survey ^a , should be less than the compliance level in each frequency range. ^b Interference may occur in the vicinity of equipment marked with the following symbol: 
NOTE 1: At 80MHz and 800MHz, the higher frequency range applies.			
NOTE 2: These guidelines may not apply in all situations. Electromagnetic propagation is affected by absorption and reflection from objects, structures and people.			
a. Field strengths from fixed transmitters, such as base stations for radio (cellular/cordless) telephones and land mobile radios, amateur radio, AM and FM radio broadcast and TV broadcast cannot be predicted theoretically with accuracy. To assess the electromagnetic environment due to fixed RF transmitters, an electromagnetic survey should be considered. If the measured field strength in the location in which NEXA™ is used exceeds 3V/m, NEXA™ should be observed to verify normal operation. If abnormal operation is observed, additional measures may be necessary, such as reorienting or relocating NEXA™. b. Over the frequency range 150 kHz to 80 MHz, field strengths should be less than 3 V/m			



ELECTROMAGNETIC COMPATIBILITY:

Recommended separation distanced between portable and mobile RF communications equipment and the NEXA™ Device			
The NEXA™ Device is intended for use in an electromagnetic environment in which radiated RF disturbances are controlled. The customer or the user of the NEXA™ Device can help prevent electromagnetic interference by maintaining a minimum distance between portable and mobile RF communications equipment (transmitters) and the NEXA™ Device as recommended below, according to maximum output power of the communications equipment.			
Rated maximum output power of transmitter (W)	Separation distance according to frequency of transmitter in meters (m)		
	150 kHz to 80 MHz d=1.2VP	80 MHz to 800 MHz d=1.2VP	800 MHz to 2.5 GHz d=2.3VP
0.01	0.12	0.12	0.23
0.1	0.38	0.38	0.73
1	1.2	1.2	2.3
10	3.8	3.8	7.3
100	12	12	23
For transmitters rated at a maximum output power not listed above, the recommended separation distance d in meters (m) can be estimated using the equation applicable to the frequency of the transmitter, where P is the maximum power rating of the transmitter in watts (W) according to the transmitter manufacturer. Note 1: At 80 MHz and 800 MHz, the separation distance for the higher frequency range applies. Note 2: These guidelines may not apply in all situations. Electromagnetic propagation is affected by absorption and reflection from structures, objects and people.			



ORDERING INFORMATION:

NEXA™ Device Kit 414-00-300-XXX (XXX indicates the country order code, contact your distributor for your order code)

CONSUMABLES:

NEXA™ Dressing -125mmHg 414-00-501 (Box of 5)
NEXA™ Dressing -75mmHg 414-00-511 (Box of 5)
NEXA™ Fluid Container Pack 414-00-502 (Box of 5)
NEXA™ Drape 414-00-600 (Box of 10)
NEXA™ Foam 414-00-700 (Box of 5)

SPARES:

NEXA™ Carry Case 414-00-400
NEXA™ Power Supply 414-00-451 (UK), 414-00-452 (EU), 414-00-453 (AUS), 414-00-454 (CHINA) with country specific adaptor.

CONTACT INFORMATION:

Notify your nursing contact if any problems or issues are encountered with the system.
For questions regarding this product, supplies, maintenance and information, contact Nexa Medical Limited:
Website: www.aotinc.net Email: customerservice@aotinc.net



Nexa Medical Limited
Suite 5-6 Willow View, Southfields, Church Lane, Bournemouth, BH22 8TR UK
www.nexamedical.com



Advena Ltd. Tower Business Centre, 2nd Flr., Tower Street, Swatar
BKR 4013 Malta

All trademarks designated herein are property of Nexa Medical Limited and its licensors.
The NEXA™ products are protected by global patents, granted and pending. PATENTS see www.nexamedical.com



This page is left intentionally blank

